



# PoolCop

## Genesis



**CATALOGUE 2025**  
**SPARE PARTS**

# PoolCop Genesis



## POOLCOP GENESIS - Exploded views

Click on the images to open the PDF

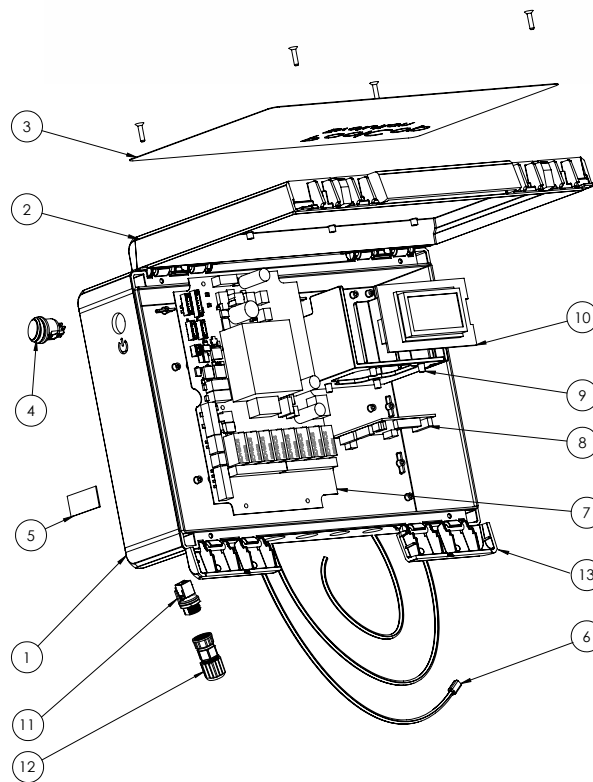

DIAGRAM 1 - DCCU

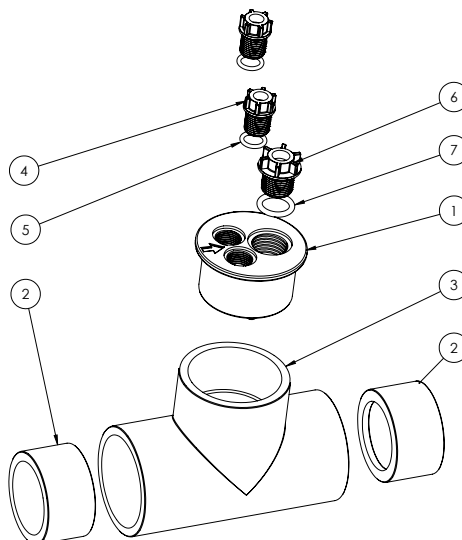













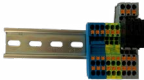



















DIAGRAM 2 - Flow Cell

Code	Designation	Part Image	Diag - Ref.
<b>Maintenance &amp; Consumables</b>			
FUS002	Spare Fuses 160mA for CCU & DCCU 230V.a.c. (10pcs)		
FUS003	Spare Fuses 315mA for 120V.a.c. CCU & DCCU (10pcs)		-
FUS006	Spare Fuses 5A Slow Blow for CCU & DCCU (10pcs)		-
AC5219	PVC Gel Aqua Glue		-
AC5222	Pack of 10 pH+ORP Sensor Cleaning Tools		-
SO4917	pH+ORP Sensor Wetting Bottle		-
<b>Parts : PoolCop Genesis</b>			
GN3201	DCCU Faceplate Genesis		DIAG 1: 2, 3
UF1140.99	CCU / DCCU Enclosure Base		DIAG 1: 1
GN1220.99	Replacement PCB Micro Kit PoolCop Genesis		DIAG 1: 10
CF1151	PCB Power Supply Kit PCB103 (including fuses) EU		DIAG 1: 7
CN1042	Pluggable Terminal Blocks Kit CCU & DCCU		-
CF1218	PCB Connection Kit SE Data		DIAG 1: 8
GN3102.01	Datalink Cable Genesis		
GN3103.01	Connection Cable PoolCop Genesis		-
GN4224	Pressure Sensor Kit, cable 4m		-
GN4211	Water Temperature Sensor Kit, cable 4m		-
CF1100.23	Air Temperature Sensor, cable 4.5m		-
GN4200	Flow Cell Kit PoolCop Genesis		DIAG 2: All
GN4205	Flow Cell Cap Kit PoolCop Genesis		DIAG 2: 1, 4, 5, 6, 7

Code	Designation	Part Image	Diag - Ref.
AC5223	Blanking Plugs Kit for VDU or Flow Cell		DIAG 2: 4, 5, 6, 7
CF1212	pH+ORP Sensor Housing Kit		-
CF1213	Fastening Kit for pH+ORP Sensor		-
CF1140.06	RJ45 Cable 1m for DCCU Black		-
CF1140.98	Panel Mount Socket Kit RJ45 IP68		DIAG 1: 11, 12
CF1114	Switch CCU & DCCU		DIAG 1: 4
AC5500	Junction Blocks Kit		-

## Parts : Options

NI2010	Waterline Level Sensor, cable 20m		-
NI4010	Buffer Tank Level Sensor (1 piece)		-
NI2020	Refill Valve 24Va.c. 3/4"		
OC0060.01	PoolCop Ocean 60 - Power Pack		-
OC0061	PoolCop Ocean 60 Cell		-
OC0120.01	PoolCop Ocean 120 - Power Pack		-
OC0121	PoolCop Ocean 120 Cell		-
OC0200.01	PoolCop Ocean 200 - Power Pack		-
OC0201	PoolCop Ocean 200 Cell		-
PD2006	Roter, Cover & Santoprene Tube Kit		-
PD2004	Suction Tube PVC Cristal 4/6mm (per metre)		-
PD2005	Injection Tube PE 4/6mm (per metre)		-
PD2002	Foot Filter		-

Code	Designation	Part Image	Diag - Ref.
PD2003	Non Return Injection Valve		-
AC6800.01	PCB Module XM8		-
AC6800.22	Cable Module XM8		-
CN1043	Pluggable Terminal Blocks Kit XM8		-
VN1000.04	Coil for Waste Valve 24Va.c.		-
PI4010	Cellular Router EU (spare part)		-
CN1063	RJ45 Cable 1m for router (Grey)		-
AC5325	Free Available Chlorine Sensor (maintenance kit included)		-
AC5330	Cable 5m for Free Available Chlorine Sensor		-
AC1003	PoolCop Modbus Adapter		-
AC5340	Free Available Chlorine Sensor Maintenance Kit		-
AC5350	Free Available Chlorine Sensor Electrolyte Gel 50ml		-
AC5360	Free Available Chlorine Sensor Prefilter Replacement Cartridge		-

# CATALOGUE NOTES

Images in this catalogue show typical products, actual components may vary; images are non-contractual. We have a permanent research and development program, and consequently we reserve the right to make changes and improvements to any of the products described in this catalogue, without prior notification. Any mention in this catalogue of the "swimming pool owner" refers to the owner of the product(s). The owner may designate a representative to act on his behalf but remains responsible for the decisions and actions of this representative

All prices are recommended public price EXW excluding VAT in EUR (PPHT€)

## GENERAL INFORMATION

### DELIVERY CONDITIONS AND CHARGES

*These are standard conditions for retail purchases. For distributors, refer to your conditions.*

Prices do not include delivery charges, which are invoiced separately as follows:

- For all orders within the European Union exceeding a value of 750 € (excluding value added tax), delivery is included free of charge.
- For all orders within European Union with a net value below 750 € (excluding value added tax), the actual delivery cost applies.
- For delivery outside of European Union and/or express deliveries, the fees will be indicated on the quote.

### GENERAL TERMS AND CONDITIONS OF SALE



[poolcop.com/general-conditions-of-sale/](http://poolcop.com/general-conditions-of-sale/)

### ECO-PARTICIPATION, WEEE

Certain products are subject to "Eco-participation" in France, which contributes to the financing of the collection and the recycling of former equivalent products (directive 2006/96/CE). Our partner for the collection and recycling of eligible products is Eco-systèmes.

Following decree No. 2009-1139 dated 22 September 2009, with regards to placing dry cell batteries and storage batteries on the market, as well as the elimination of used dry cell batteries and storage batteries, PCFR has partnered with an organization dedicated to the recycling of dry cell batteries and portable storage batteries. Our partner is SCRELEC Environnement.







[www.poolcop.com](http://www.poolcop.com)

[contact@poolcop.com](mailto:contact@poolcop.com) - +33 (4) 90 09 54 26

**PCFR PoolCop**

PCFR PoolCop  
130 Boulevard du Nord  
84160 CUCURON, France